

REI 2

User manual

Summary

1. INTRODUCTION	7
2. A LOOK AT REI2	8
2.1. Top	8
2.1.1. Printer compartment	9
2.1.2. Line keyboard	10
2.1.3. Main keyboard	11
2.2. Back	12
2.3. Connectors	12
2.4. Side	13
2.5. Materials in the REI2 package	13
3. CONVENTIONS	14
4. STARTING	15
4.1. Introduction	15
4.2. First switching on	15
4.2.1. Synchronization	15
4.2.2. Data not valid message	16
5. OPERATIONAL PHILOSOPHY	17
6. SYNCHRONIZATION OF REI2'S INTERNAL CLOCK	18
6.1. Synchronization	18
6.2. Modifying synchronization value	18
6.3. Synchronization verify	18
6.4. Signal	18
7. BATTERY RECHARGE	20
7.1. Discharge/recharge	20
7.2. Immediate recharge	20
7.3. Interrupt	21
8. BATTERY CAPACITY MEASUREMENT	22
9. RACE MANAGEMENT	23
9.1. New race	23
9.2. Delete/Retrieve stored race	23
9.3. Continue current race	23
9.4. Total memory deletion	24
10. SWITCHING OFF	25
11. MEMORIZATION	26
11.1. Memory capacity	26
12. SOFTWARE UPDATING	27
13. CONNECTION SCHEMES	28
13.1. Banana jack lines	28
13.2. DIN lines	28
13.3. LinkGate system	28
13.4. LinkPod system	29
13.5. Computer	29
13.6. Displayboards	29

13.7.	REI2 net	29
13.8.	Analogue I/O	29
13.9.	Digital I/O	29
13.10.	Power supply	30
13.11.	Starter	30
14.	MENU STRUCTURE.....	38
14.1.	Initial menu	38
15.	MAINTENANCE.....	39
15.1.	Cleaning	39
15.2.	Changing paper	39
15.3.	Releasing the paper	40
16.	CLIMATIC CONDITIONS.....	41
17.	TECHNICAL DATA.....	42
17.1.	Connectors	42
17.1.1.	Supply	43
17.1.2.	Analogue I/O	43
17.1.3.	Digital I/O	43
17.1.4.	Radio	43
17.1.5.	Computer A	43
17.1.6.	Computer B	44
17.1.7.	Display Board	44
17.1.8.	Rei2 Net	44
17.1.9.	Timing Inputs	44
17.1.10.	LinkPod	44
17.1.11.	Start	45
17.2.	Sports homologization	45
17.3.	Technical conformity certificates.....	45
18.	GUARANTEES AND RESPONSIBILITIES	46
1.	INTRODUCTION TO LINKGATE.....	48
2.	LINKGATE ENCODER: 3 FEATURES GUARANTEEING THE RELIABILITY OF RADIO TRANSMISSION.....	49
2.1.	Digital transmission of impulses.....	49
2.2.	The Repeat function	49
2.3.	Internal memorization of event times	49
3.	USING THE LINKGATE ENCODER.....	50
3.1.	Selecting the channel	50
3.2.	Selecting signal type	50
3.3.	Selecting working frequency	50
3.4.	Impulse transmission.....	51
3.5.	The repeat function	51
3.6.	Acquiring a speed.....	51
3.7.	Hardware resetting	52
3.8.	Memory resetting	52
3.9.	Synchronization	52
3.10.	Downloading data onto REI2.....	53
3.11.	Modem function.....	53
3.12.	Maintenance	54

3.12.1.	Encoder Enc003	54
3.12.2.	EncRadio Enc004 and Encoder Enc005	54
3.12.3.	Decoder e DecRadio	54
4.	LICENCES	55
5.	FIGURES	56
5.1.	Linkgate EncRadio.....	56
5.2.	Linkgate DecRadio	58
5.3.	DecRadio.....	58
5.4.	Taking the speed	59
1.	INTRODUCTION TO LINKPOD.....	61
1.1.	Information transmitted.....	61
1.2.	Measurement and speed precision	61
1.3.	The Pod	61
1.4.	Insulation.....	62
1.5.	Maintenance	62
1.	EDITING HISTORY	63

Index of figures

Fig. 1 – Overview.....	8
Fig. 2 – Printer compartment	9
Fig. 3 – Line keyboard	10
Fig. 4 – Main keyboard	11
Fig. 5 – Back (connectors).....	12
Fig. 6 – Left side (speacker connector).....	13
Fig. 7– Example of connection using the banana jack sockets.....	31
Fig. 8– Example of connection using both the banana jack sockets and the DIN sockets.	32
Fig. 9– Diagram for N/O line.....	33
Fig. 10– Diagram for N/C line	33
Fig. 11– Diagram for N/O line with 1 impulse only	34
Fig. 12– Example of connection between two computers	35
Fig. 13– Example of connection of a MicroTab displayboard	36
Fig. 14– Example of connection of two or more MicroTab displayboards	37
Fig. 15 – 6 pole DIN	42
Fig. 16 – 180° 5 pole DIN.....	42
Fig. 17 – 240° 5 pole Nucletron.....	42
Fig. 18 – Taking the speed.....	59

1. Introduction

Congratulations on choosing the Microgate REI2 stopwatch.

Microgate REI2 is a powerful and versatile stopwatch which can be expanded and configured by the user in many ways to satisfy various needs.

The software of the Microgate REI2 stopwatch includes several operating programs which allow the device to be used for most sports, during training sessions as well as in official competitions.

Some operating programs are supplied as extra options.

The main features are:

- Limited size and weight
- Quartz time base compensated for temperature with a precision of 1 PPM equal to $\pm 0,08$ s/day throughout the temperature range (-20 + 70 °C)
- Maintenance of synchronization also with the stopwatch in “standby”, once again with maximum precision (1 ppm)
- Internal memorization precision of 1/25,000 of a second
- 3 microprocessors, 2 of 8 bits and 1 of 16
- 2 MB of ROM flash memory and 2MB of RAM
- Selectable measurement precision from 1 second to 1/10,000 of a second
- Internal cadmium nickel batteries with an operational autonomy of about 20 hours and 21 days when off but with maintenance of synchronization
- 8-lines-a-second thermal graphic printer
- 240-by-64-point graphic display with lighting feature
- High quality 32-key mechanical keyboard protected by film cover
- Possibility of memorising and reusing up to 8 races with data retained also with the stopwatch switched off
- 4 direct input lines for the connection of start and finish devices (gates, photocells....)
- Connectable to LinkGate and LinkPod systems
- Connections for analogue and digital devices
- Serial connections for connection of computers and displayboards

REI2 is part of a series of products created by Microgate for the management of sports events. The main products which can be connected to REI2 include:

- LinkGate system for the radio transmission of timing impulses (see relative appendix)
- LinkPod system for the radio transmission of timing impulses (see relative appendix)
- Starting gates
- Polifemo photocells
- Barrier photocells
- MicroTab alphanumeric displayboards
- MicroGraph graphic displayboards
- MicroClima climatic sensor for acquiring air temperature and humidity and snow temperature
- MicroSem signal light
- Electronic Bang, the starting bang

This manual refers to the Kernel 1.07.9 software version.

2. A look at REI2

2.1. Top

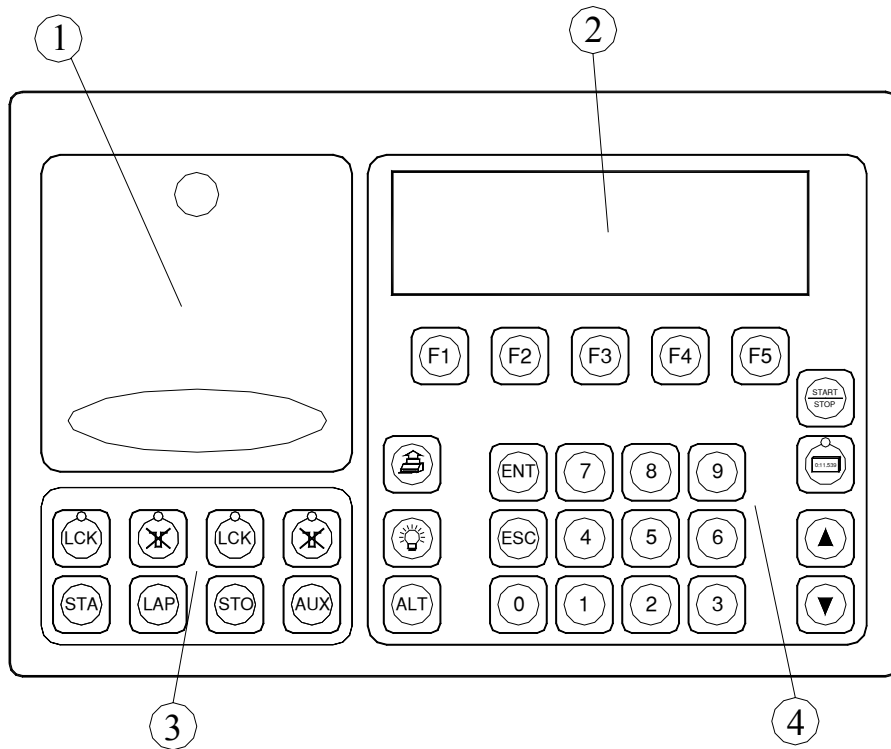

Fig. 1 – Overview

- 1 Printer compartment
- 2 Graphic display
- 3 Line keyboard
- 4 Main keyboard

2.1.1. Printer compartment

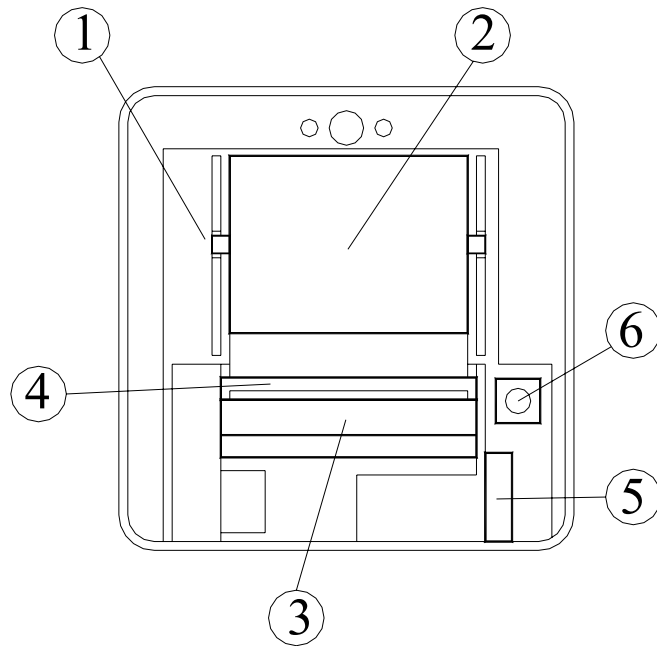

Fig. 2 – Printer compartment

- 1 Slot for spindle
- 2 Paper compartment
- 3 Thermal head
- 4 Roller
- 5 Head block lever
- 6 <Reset> button for complete annulment of REI2

2.1.2. Line keyboard

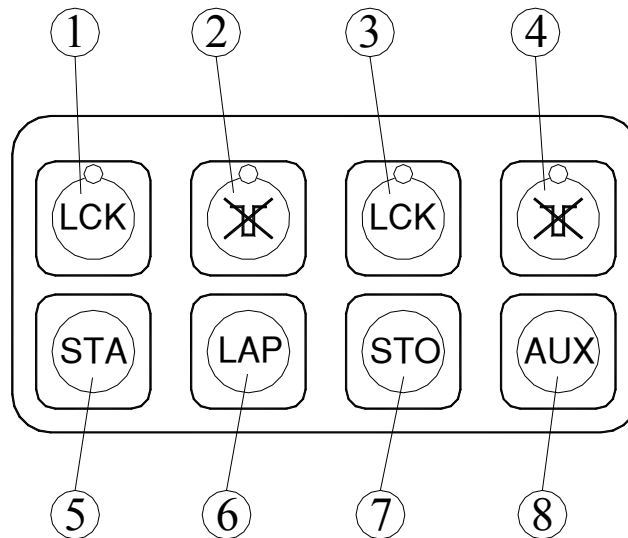

Fig. 3 – Line keyboard

- 1 <LCK> Software block on the lines selected by the user with activation signal led
- 2 <ARM> Immediate Rearm on the lines selected by the user with activation signal led
- 3 <LCK> Software block on the Stop line with activation signal led
- 4 <ARM> Immediate Rearm of the Stop line with activation signal led
- 5 <STA> manual Start impulse
- 6 <LAP> manual intermediate impulse
- 7 <STO> manual Stop impulse
- 8 <AUX> manual auxiliary impulse

Allocation of the 'channel' on which the <STA> <LAP> <STO> and <AUX> keys operate can be modified in accordance with the program.

2.1.3. Main keyboard

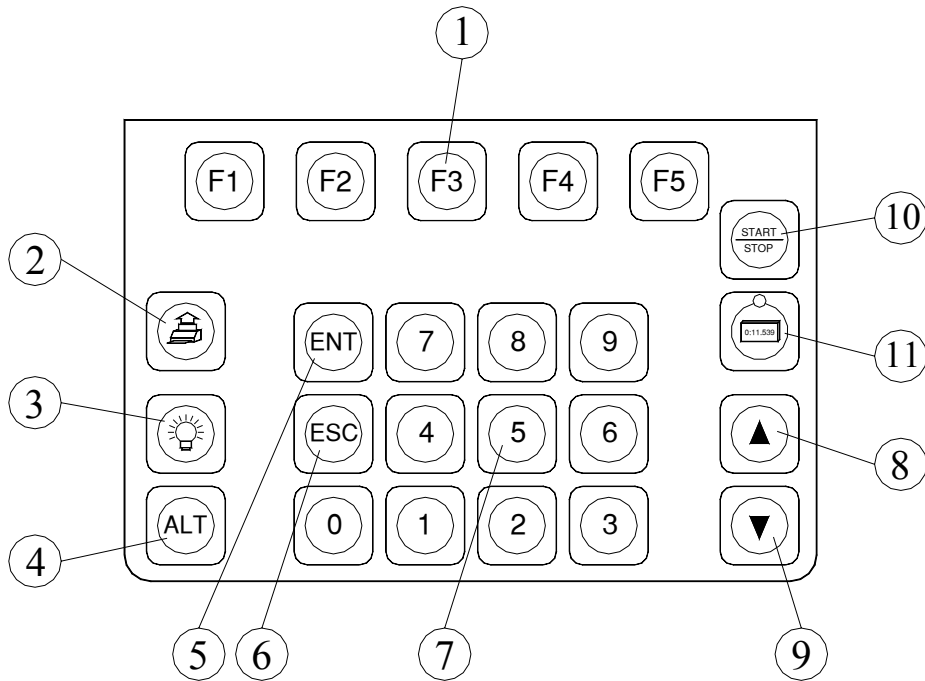

Fig. 4 – Main keyboard

- 1 <F1> <F2> <F3> <F4> <F5> function keys
- 2 <Printer> key: when pressed alone it winds the paper forward, together with the <ALT> key it winds it back
- 3 <Light > key activates the back lighting of the graphic display
- 4 <ALT> key modifies the functioning of the other keys
- 5 <ENT> key usually confirms what is done
- 6 <ESC> key usually allows you to quit what you are doing
- 7 Numeric keyboard
- 8 <Arrow up> key
- 9 <Arrow down>key
- 10 <Displayboard> key with activation led allows you to manage the functioning of the displayboard/displayboards
- 11 <Start/Stop> key modifies the types of event on which you are working

The functioning of the various keys can change according to the program used.

2.2. Back

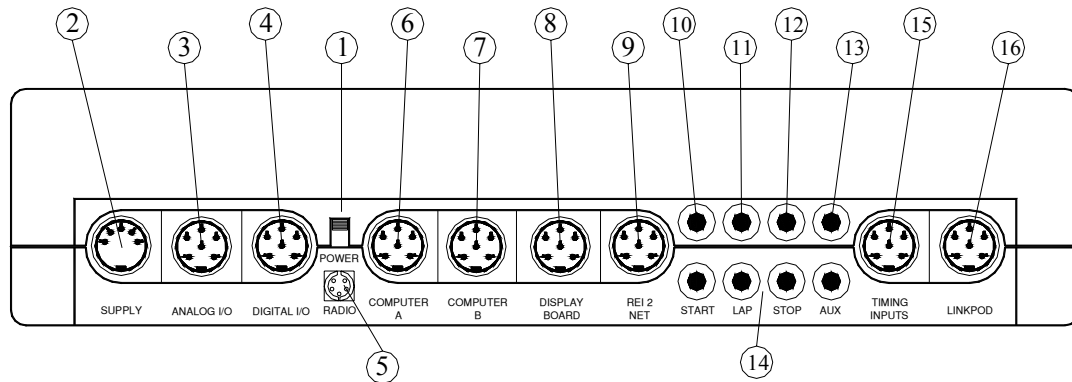

Fig. 5 – Back (connectors)

2.3. Connectors

1. On/Off Switch
2. Power
3. Analogue inputs for the connection of sensors with analogue outputs, such as the sensors for air temperature/humidity and snow temperature
4. Digital input output for connection to devices with digital command (e.g. MicroSem signal light) or unblocking devices
5. Input for LinkGate Decoder and DecRadio connection
6. Serial I/O 'A' for computer connection
7. Serial I/O 'B' for computer connection. The two connections can supply and receive different data simultaneously
8. Connection for displayboards
9. Connection for REI2 NET network – a number of REI2 operators collaborate at the same event
10. Start line input
11. Lap line input
12. Stop line input
13. Aux line input
14. Grounds
15. Lines: input (duplicated) of the main lines
16. Connection for LinkPod system

2.4. Side

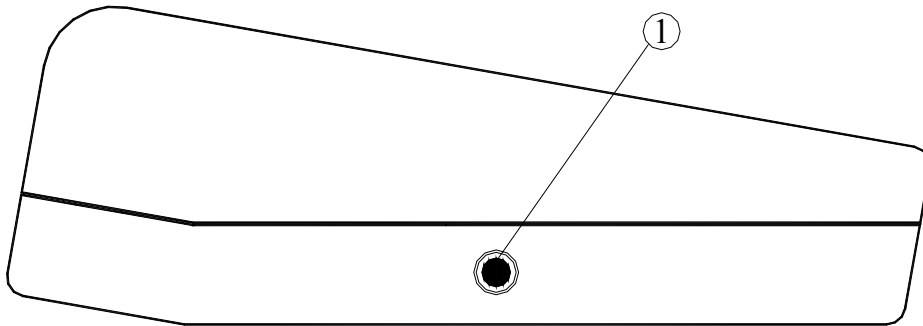

Fig. 6 – Left side (speaker connector)

1 External speaker connector

2.5. Materials in the REI2 package



REI2 is supplied togetherwith the following material:

- The REI2 stopwatch
- A bag for transport
- Adaptor/battery charger
- REI2 / PC connection cable
- Two rolls of thermal paper

3. Conventions

In this manual the keys to be pressed are shown inside chevrons. For example, press <**F1**> means the yellow key marked F1, while the options proposed by REI2 are indicated in bold type.

This symbol  draws your attention to points about which you must be particularly careful.

This symbol   draws your attention to points about which you must be extremely careful.

4. Starting

4.1. Introduction

The best way to learn to use Microgate's REI2 stopwatch is to begin trying. Bear in mind that there is no sequence of keys which can damage your stopwatch. However, make sure you read this manual carefully before connecting any accessories.

This chapter will guide you step by step in the operations to be carried out when starting to use your REI2.

4.2. First switching on

Start by connecting the mains power supply to the Supply connector, wait a few seconds and switch on the device.

In the initial screen display the firmware release and language appear for a few seconds. In this case you will see 1.07.9 followed by 0 or 1 indicating the battery type. 1 indicates longlife batteries while 0 indicates standard duration.

Note: The request for synchronization does not appear if the internal clock of your REI2 is still synchronized; the data not valid message does not appear if REI2's memory contains valid data.

4.2.1. Synchronization

```
!!! ATTENTION !!!
The system has lost synchronization
A) Synchronize
B) Do not synchronize

A      B
```

The first time REI2 is switched on, its internal clock is not synchronized. With <F1> select the option **Synchronize**

```
*** SYNCHRONIZATION ***
Insert the time 00:00:00.0000
```

You are asked for the time of synchronization. Insert real time, for example 9.30, with the keys <9> <ENT> <3> <0> <ENT> <ENT> <ENT>

```
*** SYNCHRONIZATION ***
Insert the time 09:30:00.0000
Insert the date 1/01/1999
```

You are now asked for the date, for example, 3 June 2003. To insert it, press <3> <ENT><6> <ENT> <2> <0> <0> <3> <ENT>

```

*** SYNCHRONIZATION ***
Input hour   09:30:00.0000
Input date   03/06/2003

Correct OK   menu

```

Now confirm the data you have inserted with the <F4> key

```

*** SYNCHRONIZATION ***
Input hour   09:30:00.0000
Input date   03/06/2003
START to synchronize!

menu

```

REI2 is now ready to be synchronized. Give a short impulse with the <STA> key

```

*** SYNCHRONIZATION***
Input hour   09:30:00.0000
Input date   03/06/2003
START to synchronize!
SYNCHRONIZED!!

menu

```

As soon as the impulse has been received, the message 'SYNCHRONIZED' appears for a few moments

```

*** SYNCHRONIZATION ***
Input hour   09:30:00.0000
Input date   03/06/2003
START to synchronize
SYNCHRONIZED!!

menu

```

4.2.2. Data not valid message

```

09:30:30.3

ATTENTION MEMORY CORRUPTED
Press ENTER to continue

```

On the left of the display the internal running clock appears. Initially REI2 has no valid data in its memory and the user is informed of this. Press <ENT> to continue.

5. Operational philosophy

The various choices possible as regards the various menu choices, the various options and the various modifiable values are assigned each time to the 5 function keys <F1>...<F5>. All the operational choices are shown on the bottom line of the display.

There are two possible assignment modes:

1. A function/choice appears above the corresponding function key
2. A letter at the beginning of the line refers to the corresponding function key.

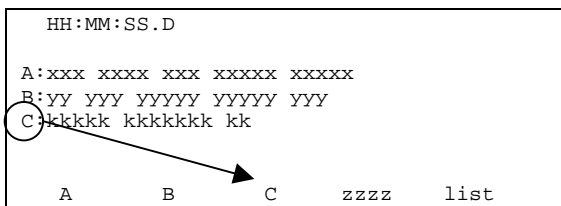

↓
1: Press <F5> to activate this function

2: Press <F3> to activate this choice

The presence or absence of particular choices depends on the function/program activated.

It will often be necessary to insert numerical data (for example, an athlete's start number) with the numeric keyboard. The possibility of doing this is indicated by the presence of a cursor (vertical bar or black square) on the field concerned. After setting the required value, this value can be confirmed by pressing <ENT>.

The <ALT> key does not have its own function but is used simultaneously with other keys to modify their behaviour.

The <ESC> key has several functions

- Inside a menu it allows you to return to the previous menu
- During the insertion of a numerical value, it deletes the last figure keyed in and if pressed down for a long time it deletes the whole field.

6. Synchronization of REI2's internal clock

REI2 can be synchronized by means of the keyboard, the external line or via radio with the LinkGate system. If necessary, synchronization can be corrected by putting the internal clock forward or back.

6.1. Synchronization

Through this function, REI2's internal clock is synchronized. The operation is performed by inserting the time of synchronization, confirming each field (hour, minutes, ...) with the <ENT> key and then the date.

Attention: To be able to carry out synchronization the start line must be 'at rest' when <F4> is pressed (open for line N/O, closed for line N/C). If the line is not 'at rest', the message '!!!ATTENTION!!! START line unable to give synchronization impulse.....' will appear.

With:

- <F2> the inserted data can be modified if a mistake has been
- <F4> to confirm synchronization data. With the next start impulse, the internal clock starts
- <F5> to return to the previous menu.

6.2. Modifying synchronization value

In certain situations it may be necessary to change the synchronization of REI2 to align it with other devices which cannot be resynchronized. After establishing the gap in synchronization between the two devices (for example with a stop in parallel), insert its value as '**Time change**' (paying attention to the alignment; for example, 3 hundredths should be inserted as 300 ten-thousandths). The date can also be changed. Each value should be confirmed with <ENT>.

The enabled function keys are:

- <F1> **Time+** to change the sign of variation, with each press it enables the increase or reduction of values
- <F3> **Correct** to change any incorrectly inserted data
- <F4> **OK** to carry out correction of synchronization
- <F5> **menu** to quit the function.

6.3. Synchronization verify

Calling up this function makes REI2 ready to receive an impulse from a line (main or LinkPod) or the LinkGate system

The message **SYNCHRONIZATION VERIFY – Wait for impulse...** appears on the display. When REI2 receives an impulse, the channel the impulse comes from and the date and time when it was acquired are printed on the printed strip.

6.4. Signal

With this function a synchronization impulse for the synchronization of other devices can be generated. When the function is activated, a request is made for the time and date for generation of the impulse. Every value must be confirmed with <ENT>.

The signal is generated by switching pin 6 of the I/O digital port to level 0.

7. Battery recharge

During normal functioning, the presence of a valid external source of power supply (with a socket as symbol) or low battery condition (with the symbol of a battery) is shown in the display to the right of the first line. From the moment the symbol appears, about 90 minutes of autonomy remain.

Recharging of REI2's internal batteries is managed entirely by the microprocessor. In this way it has been possible to implement a recharge control which guarantees maximum efficiency of the batteries at all times, at the same time prolonging their operational life.

When you enter this function, the current state of power supply is shown on the sixth line of the display as follows:

- **'Battery use ...'** the internal batteries are being used
- **'Maintenance'** the stopwatch is supplied by the external power source and at the same time the efficiency of the batteries is maintained by a trickle charge but they are NOT recharged
- **'Discharge...'** the internal batteries are completely discharged before being subsequently recharged
- **'Recharge'** recharge in progress; on the right, the time remaining before the end of recharge is shown
- **'Recharge blocked'** recharge has been temporarily interrupted because of insufficient voltage. It will resume automatically as soon as a voltage level is restored.

To recharge the batteries, connect the plug for recharging to any continuous current supply between 11 and 24 volts. In the REI2 package a special adaptor is provided for mains power supply (220V).



To recharge the batteries or completely discharge them, REI2 must remain switched on. During recharge it is possible to carry out every kind of timing. The important thing is not to switch it off.



After a reset the battery gauge cannot calculate the battery status correctly (). It will therefore be necessary to carry out a Charge/Recharge cycle to have accurate knowledge of battery status.

7.1. Discharge/recharge

When this function is selected, the internal batteries are first completely discharged and then recharged. This is the most correct procedure for keeping the internal batteries at maximum efficiency.

The duration of the discharge phase depends on how fully the batteries are charged and can last up to about 3 hours.

The duration of the subsequent recharge phase is 7 hours for the old type of battery (in version 1.07.9.0), while for the new type (in version 1.07.9.1) it is about 9 hours 15 minutes. At the end of recharge the message **'RECHARGE OK!'** appears.

7.2. Immediate recharge

If it is not possible to charge or recharge in the correct way because of lack of time or for any other reason, it is possible just to recharge. In this way recharge time is reduced but this procedure is not recommended as it reduces the efficiency of the batteries.

7.3. *Interrupt*

With this function the discharge and recharge phases are interrupted. REI2 returns to maintenance status until external power is present.

8. Battery capacity measurement

This function is used for accurate regulation of the residual battery charge.

This operation should be repeated every 6 months to offset natural deterioration in the performance of the internal batteries.

First REI2 discharges the batteries, then it fully recharges them, discharges them and finally fully recharges them again. All these operations take about 24 hours.

9. Race management

REI2 can memorise up to 8 different races and their relative configurations. It is possible to suspend a race at any moment, to manage a different one and then to retrieve the suspended race.

As soon as REI2 has finished checking synchronization and memory content it activates the race management menu.

At the end of timing, no operation is necessary to memorise a race. All the data is automatically recorded in the memory of the stopwatch and retained also when the machine is switched off. For stored data retention times, consult section 11, Memorization, on p. 26.

9.1. *New race*

Selecting this option allows you to start a new race. You are asked for the program to be used and when you have selected this, you are given the indication '**NEW RACE**' and the number assigned on the printout.

If all the eight races available have been stored, the message '**ATTENTION! – Race Memory Full – Delete one or more races – Press a key to continue**' appears and you must delete one of the stored races to be able to continue.

9.2. *Delete/Retrieve stored race*

This option allows you to retrieve or delete a previously stored race from the list of races proposed.

In the column:

- **RACE** the consecutive race number appears. The symbol * to the left of the number indicates the last active race, which is retrieved if 9.3, Continue current race, is selected.
- **DATE** the start date
- **START** the start time
- **TYPE** the type of program used for the race.

The positions which are free for memorization of a race are indicated by '---'.

The enabled function keys are:

- <F1> ↑: to scroll the race list up
- <F2> ↓: to scroll the list down
- <F3> to delete the race shown by the symbol ◀. You are requested to confirm that you wish to delete the race, <F4> to delete, <F5> to annul deletion. If you select an unused race number, the message '**Deletion impossible**' appears
- <F4> retrieves the race indicated by the symbol ◀ and allows you to resume timing of it. If you select an unused race number, the message '**Race not available**' appears
- <F5> to return to the previous menu.

9.3. *Continue current race*

By selecting this option, you resume timing of the last race stored, and retain all its timings and configuration settings.

9.4. Total memory deletion

Selecting this option allows you to delete all the data of all the stored races. On the display the message ‘***** ATTENTION ***** - **All data and races will be irreversibly cancelled, proceed?**’ Press <F4> for **Yes** to delete all the stored races, press <F5> for **No** to annul the deletion operation.

10. Switching off

Operating the switch on the back of REI2 activates its switching off function (see fig. 5 ref. 1). At this point there are 3 possibilities:

Pressing key <F1> for **SWITCH OFF** switches off the stopwatch completely with retention of all the data stored but the loss of synchronization.

Pressing the key <F3> for **STANDBY** puts REI2 in a state of suspension: everything is switched off except the time base. In this way, as well as the data stored, the device also retains synchronization set at the regular precision of 1 ppm.

Pressing the key <F5> for **CONTINUE** annuls switching off and returns you to the same point you were in before operating the switch.

11. Memorization

The duration of retention of the data stored by REI2 depends on the choice made when switching off. The following table summarises the typical values for fully charged internal batteries in good condition.

	Off	Standby
Race results and configuration	More than 30 days	More than 15 days
Synchronization set	Not retained	More than 15 days

11.1. Memory capacity

REI2 has a 2 MB memory for storing events and the configurations of various races. This memory is big enough to store about 65,000 events.

When the memory is full, the message **Memory full** appears on the last line of the display. In this situation, REI2 records the last event acquired by deleting the penultimate one so that it can in any case be printed. Space for the race in progress can be freed by deleting one of the stored races.

65,000 events correspond to approximately 8 single start races of about 2000 competitors each, in which Start, Stop and two intermediate events are taken.

12. Software updating

The software of the REI2 stopwatch is recorded in flash memory and can be updated if new versions or updates are released.

Each software update is 'labelled' with an identity number composed of 2 groups of figures separated by a dot. The first group represents the version. It is modified only if important improvements are made and this always entails changes in the manual. The second group represents the release and can reflect internal improvements to the program which are not visible to the user or improvements of functional characteristics which entail changes in the user manual (e.g. 1.00). If there is a third group of figures, this represents an update of the release indicated (e.g.: 1.05.4 indicates an update to release 5 of version 1).

The various updates and the program for downloading the updates, microFlasher.exe., will be made available on Microgate's internet site at WWW.MICROGATE.IT in the download section.

Details of the software versions available and any modifications to ways of updating will be published on the same site.

To carry out updating you will require a personal computer with a Windows 95 or higher operating system, with a free serial port and the dedicated REI2-PC connecting cable. Here are the steps you must follow:

- Connect the PC serial output to the REI2 **Computer A** input.
- Switch on REI2 by keeping the keys <F1> <F2> and <F3> simultaneously pressed down. The serial number of the stopwatch and the wait message for connection to the computer ('**Waiting for PC connection...**') will appear
- Launch the microFlasher program on the PC
- Recognition of the program to be updated will be indicated in the events window. The serial port on which the attempt is made is shown in the field '**Serial communication**'
- At the moment the program establishes connection with REI2, program transfer begins. The continuation of the operation is indicated with a 'thermometer' in the program
- When the operation is terminated, the message '**Device correctly programmed**' appears on the computer while the message '**Device successfully programmed**' appears on REI2's display
- Disconnect the cable between the PC and REI2 and reset the stopwatch by pressing the **reset** button inside the printer compartment
- In the 'Race management' menu, carry out 'Clear all memory' (see, for example, section 20.4 in the 'Single starts manual').

Notes:

If program transmission does not begin within 30 seconds, check whether the connection is correct and try again.

At the end of program transfer REI2 checks the quality of the program received. If there is an error a message appears, informing you of this. In this case it is possible to reset REI2 and to carry out programming again.

13. Connection schemes

Below, several of the most frequently used connection modes are shown as examples. Although all the connections are fitted with safety circuits to protect against short-circuits, you should be careful to avoid any short-circuits.



With the exception of the power socket, which should however only be used within the defined ranges, no source of power should be applied to any contact if you wish to avoid possible damage to the stopwatch and the peripherals connected to it.



REI2 AND ANY PERIPHERALS AND ACCESSORIES SHOULD BE CONNECTED TO THE MAINS SUPPLY (220V) ONLY WITH THE DEDICATED ADAPTORS. CONNECTION CABLES FOUND CONNECTED UP SHOULD BE CONSIDERED 'LIVE' UNTIL YOU HAVE PROOF TO THE CONTRARY.

13.1. Banana jack lines

REI2 accepts command devices with contact either normally open or normally closed. To connect devices which do not require power or have their own power supply, 4 input lines are available: Start, Lap (intermediate), Stop and Aux (auxiliary), all configurable in accordance with the program used. Each line has its own ground contact. All the grounds are connected to each other and therefore equivalent and invertible.

Fig. 7 shows an example of connection using banana jacks.

13.2. DIN lines

On the DIN connector the same 4 lines and the relative ground are available together with stabilised power supply for powering external devices such as cells. It is therefore possible to power the external device without 'consuming' the charge of the batteries in it, in the case of devices which have them (for example, the Polifemo cell), or to power devices which do not have them (e.g. LBM1 cells).

The contacts are connected in parallel to those on the banana jacks.

Fig. 8 shows an example of a connection using the lines on the DIN connector. This connection, with the Polifemo cell configured in Stop, is similar to the one in section 13.1, Banana jack lines.

For N/O contacts, the contact is considered closed when a voltage signal of at least 2,8 volts for the duration of 1/10,000s is detected and reopened with a fall of 2,2v for 1/1,000s, while for N/C the contact is considered open when a current signal of 2,8 v for the duration of 1/10,000s is detected and reclosed at 2,2v per 1/1,000s (difference of potential between line and ground).

Both for the N/O lines and the N/C lines all events inside 1/1000s (antibounce circuit) from the event detected are ignored. The maximum recommended load on the lines is 2 K Ω .

See Fig. 9 and Fig. 10 for the relative schemes and Fig. 11 for an example of impulses 'discarded' after the first one. The schemes are NOT to scale.

13.3. LinkGate system

For details of the connection modes of the LinkGate system, see appendix 'B'.

13.4. *LinkPod system*

For details of the connection modes of the LinkPod system, see appendix ‘C’.

13.5. *Computer*

REI2 has two separate connection ports, individually configurable, for dialogue with electronic processors. The standard supported is RS 232. Although contacts for hardware flow control are present, in this kernel version these are not managed. Instead, an Xon/Xoff software control is implemented using the suspension and resumption commands (for details, see appendix D).

Fig. 12 shows an example of connection between REI2 and two different processors.

13.6. *Displayboards*

Fig. 13 and Fig. 14 are examples of the connection of one or more Microgate μ TAB master displayboards to REI2. The first displayboard is connected to the ‘**Displayboard**’ output of the stopwatch, the second, and any others used, to the ‘**Serial 2**’ port of the first displayboard. For further details about displayboard connection modes, consult the relative manual.

On the ‘**Displayboard**’ connector the output to the displayboards is available both in the standard RS232, the one typically used for connection of Microtab displayboards, and in RS485, preferred for connection to MicroGraph displayboards.

As default values, the RS232 output has 1200 bps, 8 bits of data, 1 stop no parity.

Although a computer can be connected to this output to intercept data sent to the displayboards and to maintain compatibility with software already written, it should be remembered that the data displayed is limited to what is necessary for the functioning of the displayboards and the output cannot be configured.

13.7. *REI2 net*

This port is reserved EXCLUSIVELY for the connection of other Microgate devices (e.g. REI2), using the respective REI2 NET ports and the dedicated Microgate cables cod. CAB091.

13.8. *Analogue I/O*

This connector allows you to connect external data acquisition devices to one of the 3 analogue/digital 13-bit converters inside REI2. Typical of these instruments is the μ Clima sensor for measuring air temperature and humidity and snow temperature. The voltage range accepted is from 0 to 5 volts. The reading frequency can be programmed via software and the value has been arrived at through the carefully calculated average of 66 repeated readings.

13.9. *Digital I/O*

5 digital signals are available on this connector. 4 of them are configurable, individually via the software, at the input or output, and in the case of one signal, only at the output. The output level is 0 volts for the value 0 and 5 volts for the value 1, while the input value is between 0 and 2 volts for the value 0 and between 3 and 5 volts for the value 1.

The signal light Microgate μ SEM can be connected to this port.

The maximum current available on this connector is 5 milliamperes.

13.10. Power supply

The external power source such as, for example, the adaptor/battery charger supplied in the REI2 package, should be connected to this connector. REI2 accepts a voltage of between 9 and 24 volts on the input. Keep in mind that with voltages between 9 and 11 volts the internal batteries cannot be recharged but only 'maintained' (see section 7, Battery recharge on page 20).

13.11. Starter

An acoustic start device can be connected to this connector, which is located on the left side of REI2.

The minimum load allowed is 4 Ω .

Fig. 7– Example of connection using the banana jack sockets

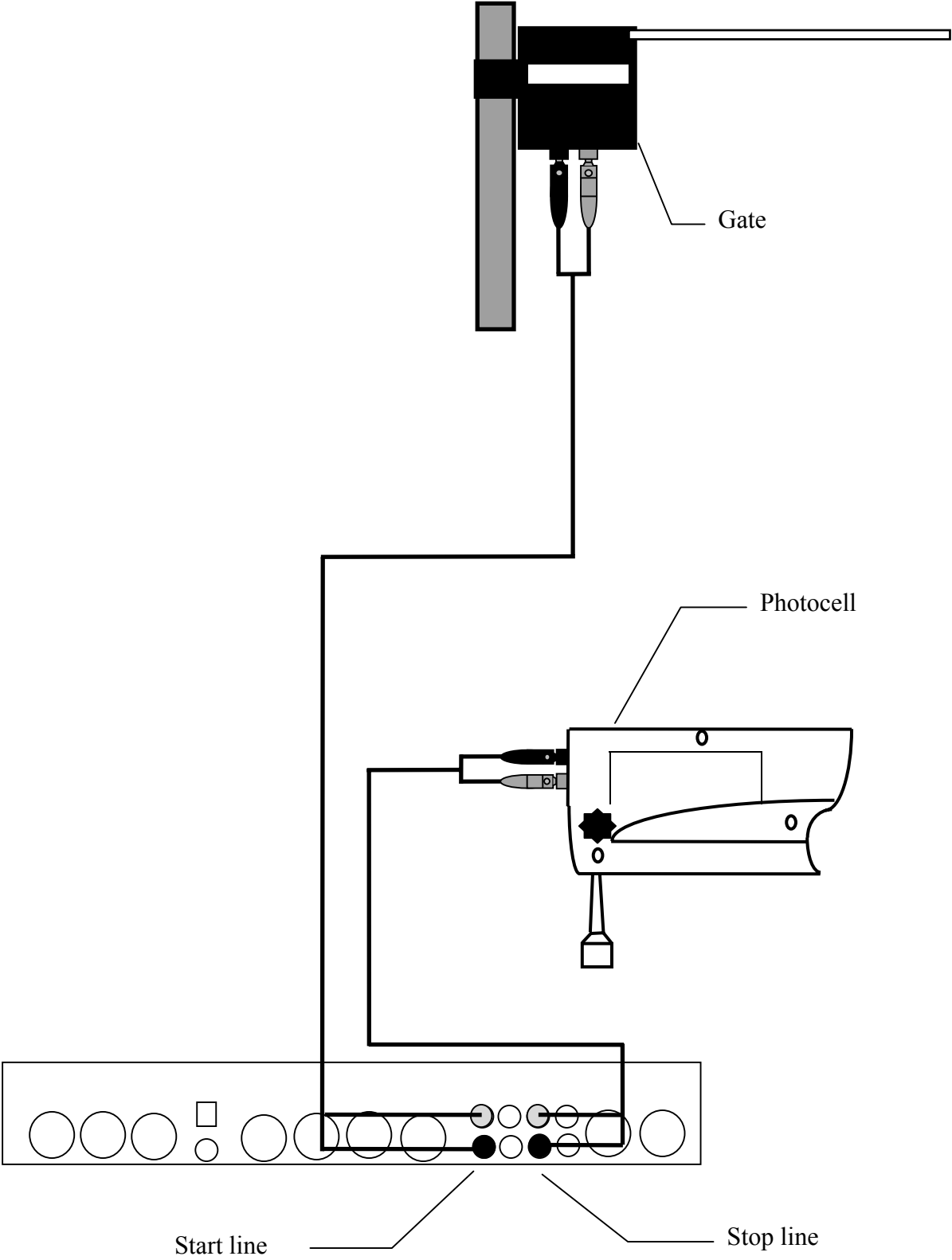

Fig. 8– Example of connection using both the banana jack sockets and the DIN sockets.

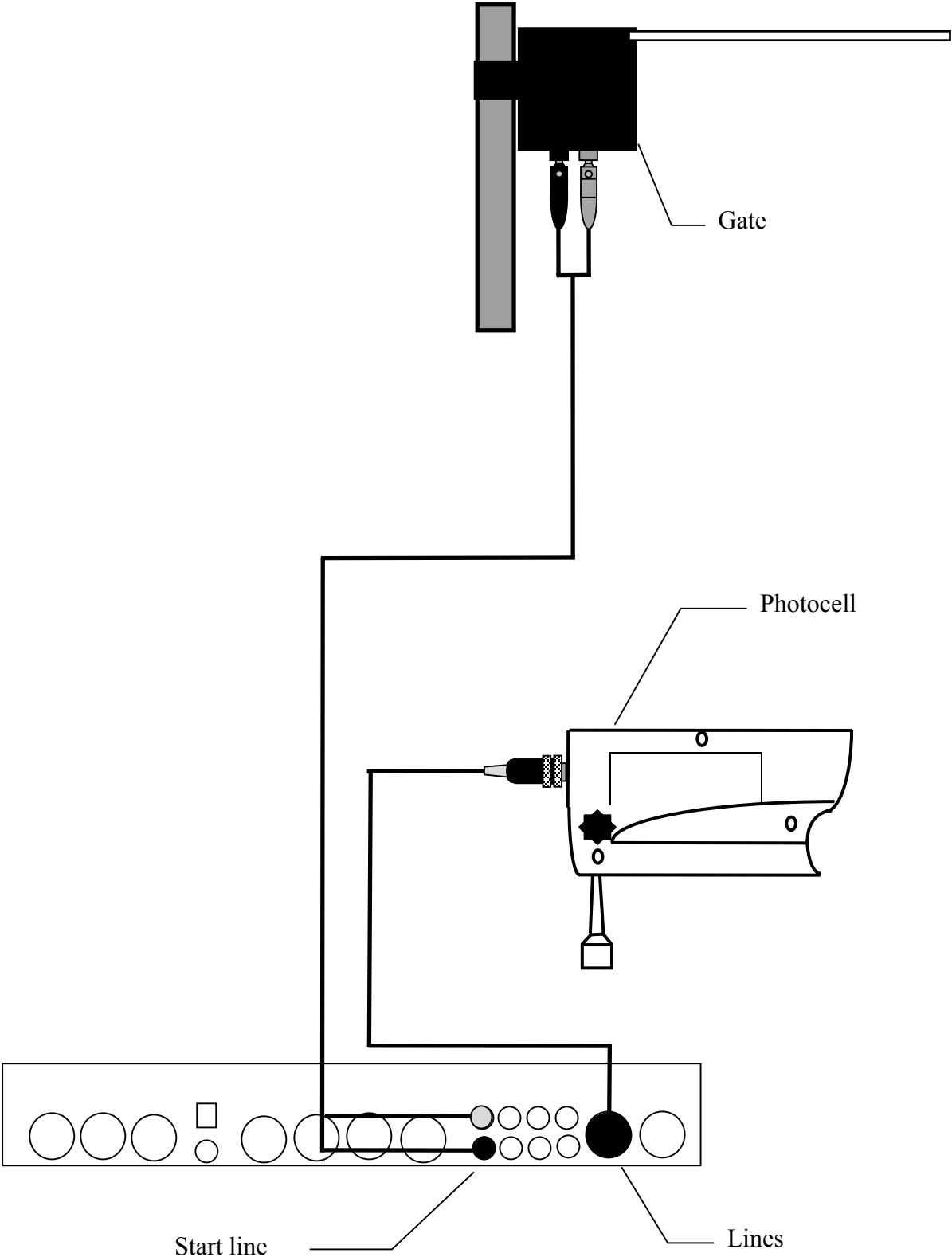

Fig. 9– Diagram for N/O line

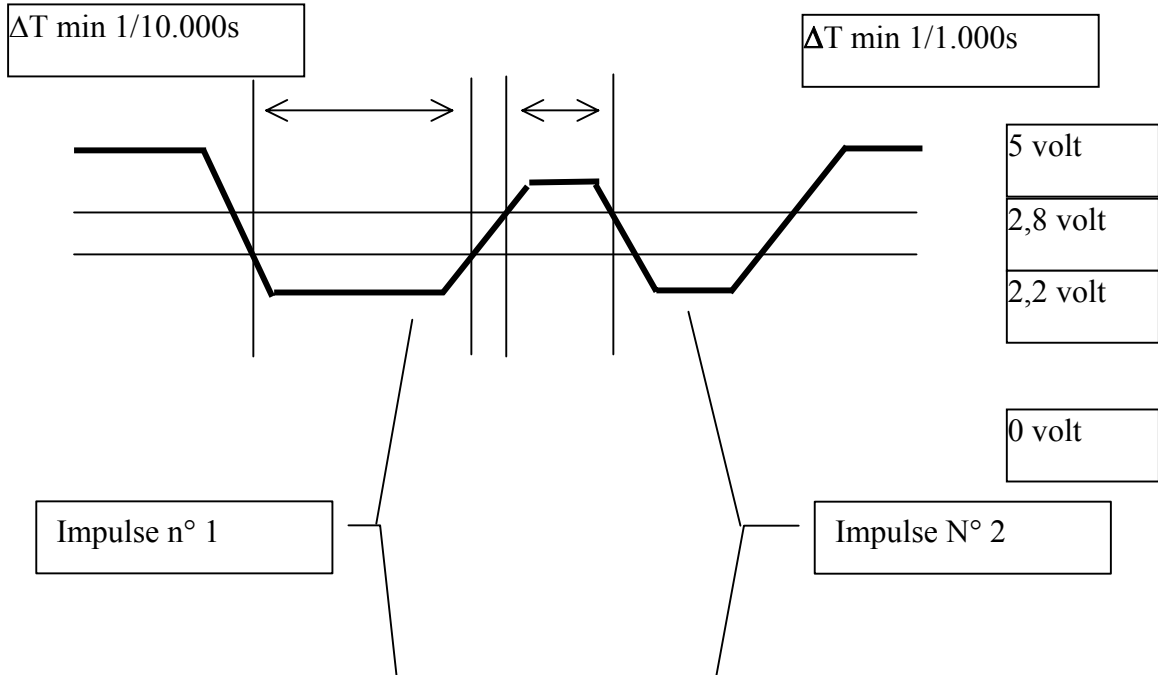

Fig. 10– Diagram for N/C line

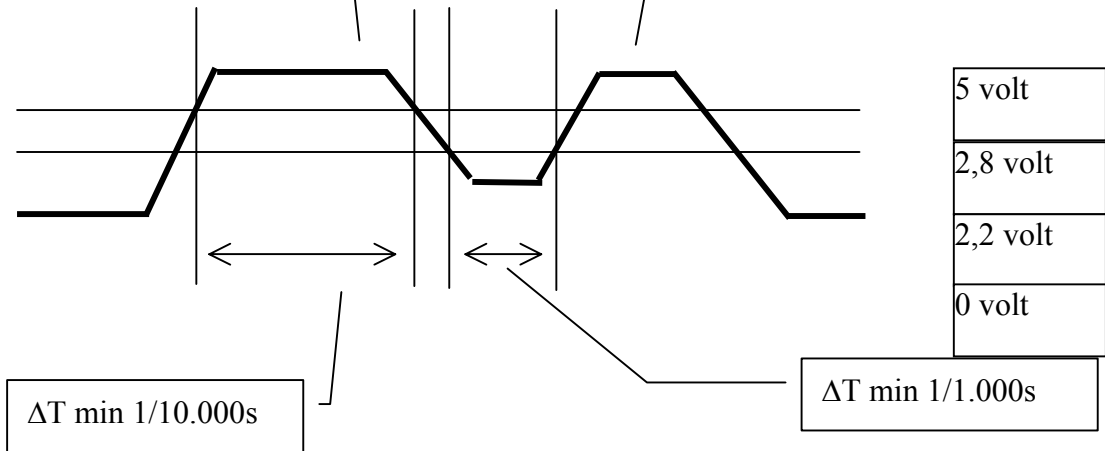

Fig. 11– Diagram for N/O line with 1 impulse only

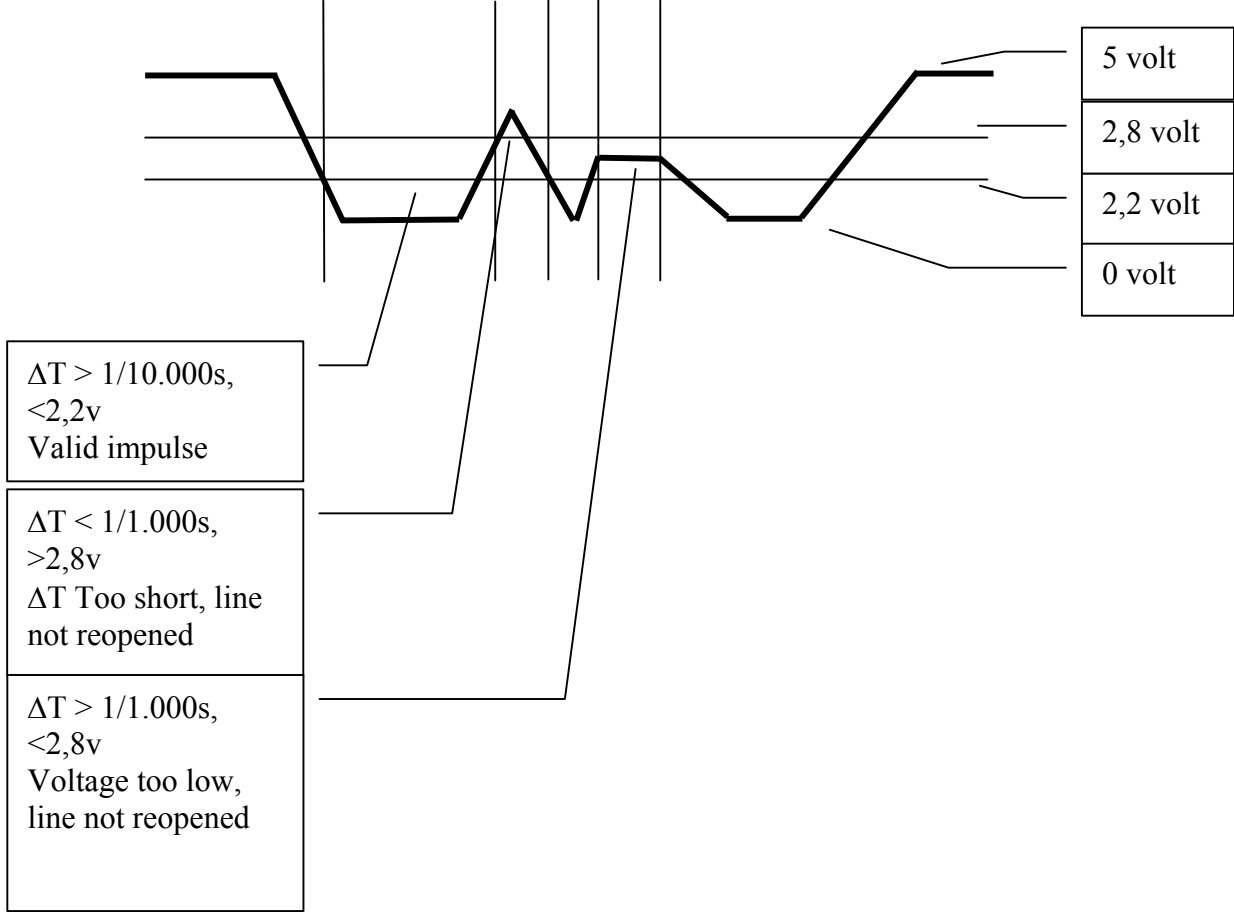

Fig. 12– Example of connection between two computers

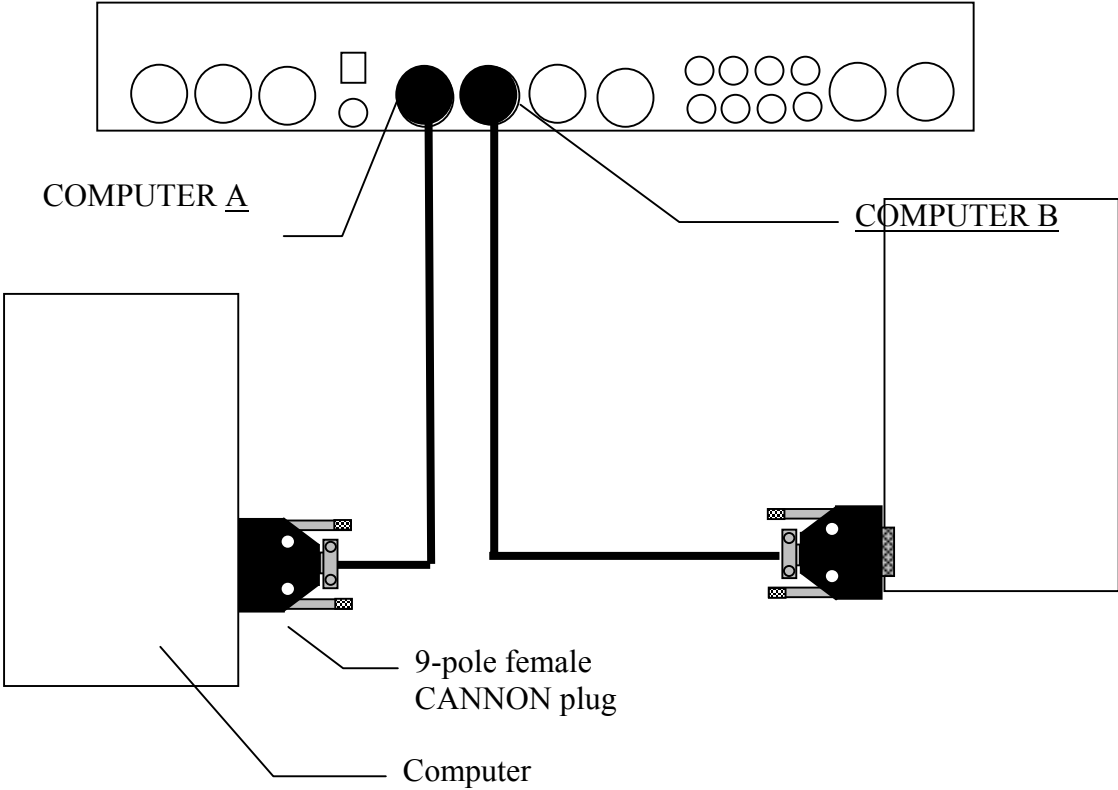

Fig. 13– Example of connection of a MicroTab displayboard

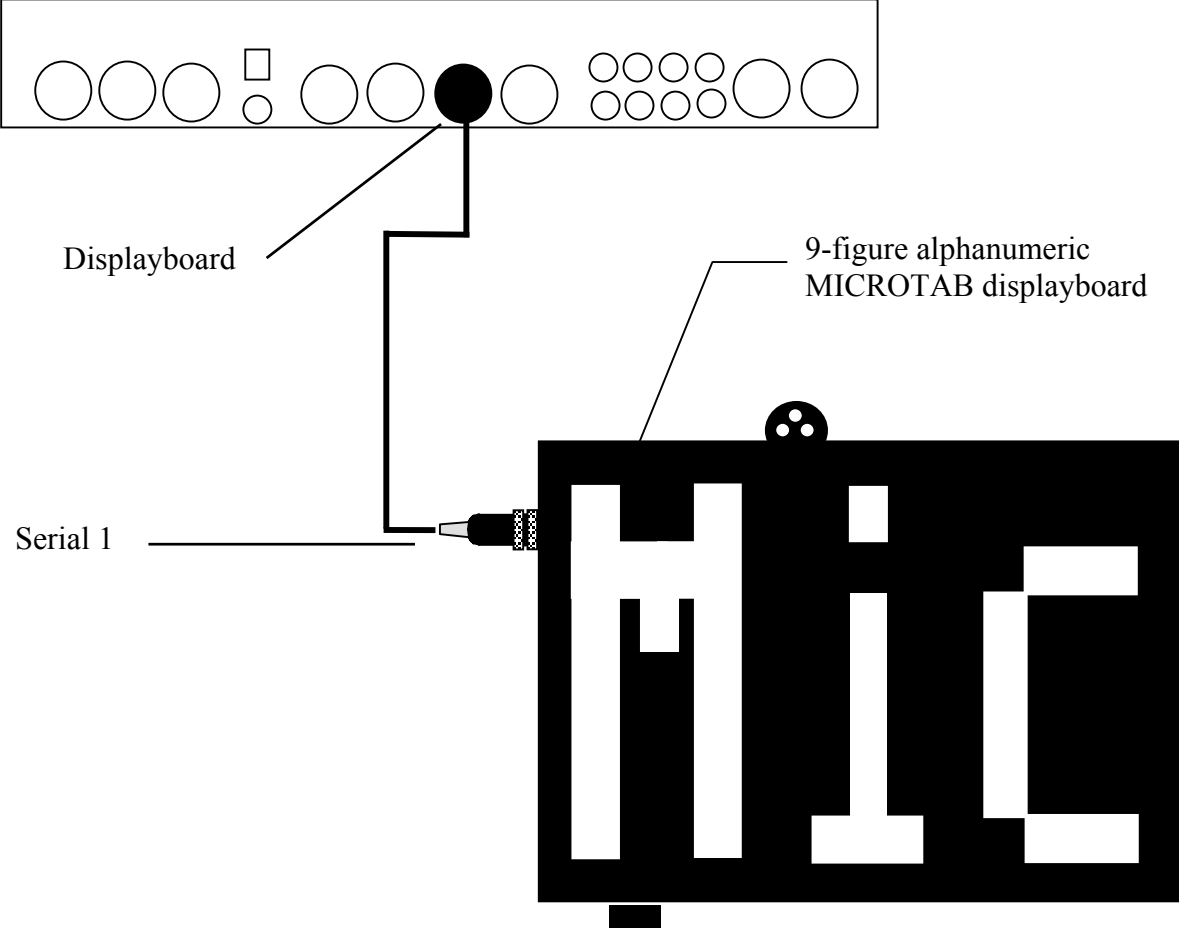
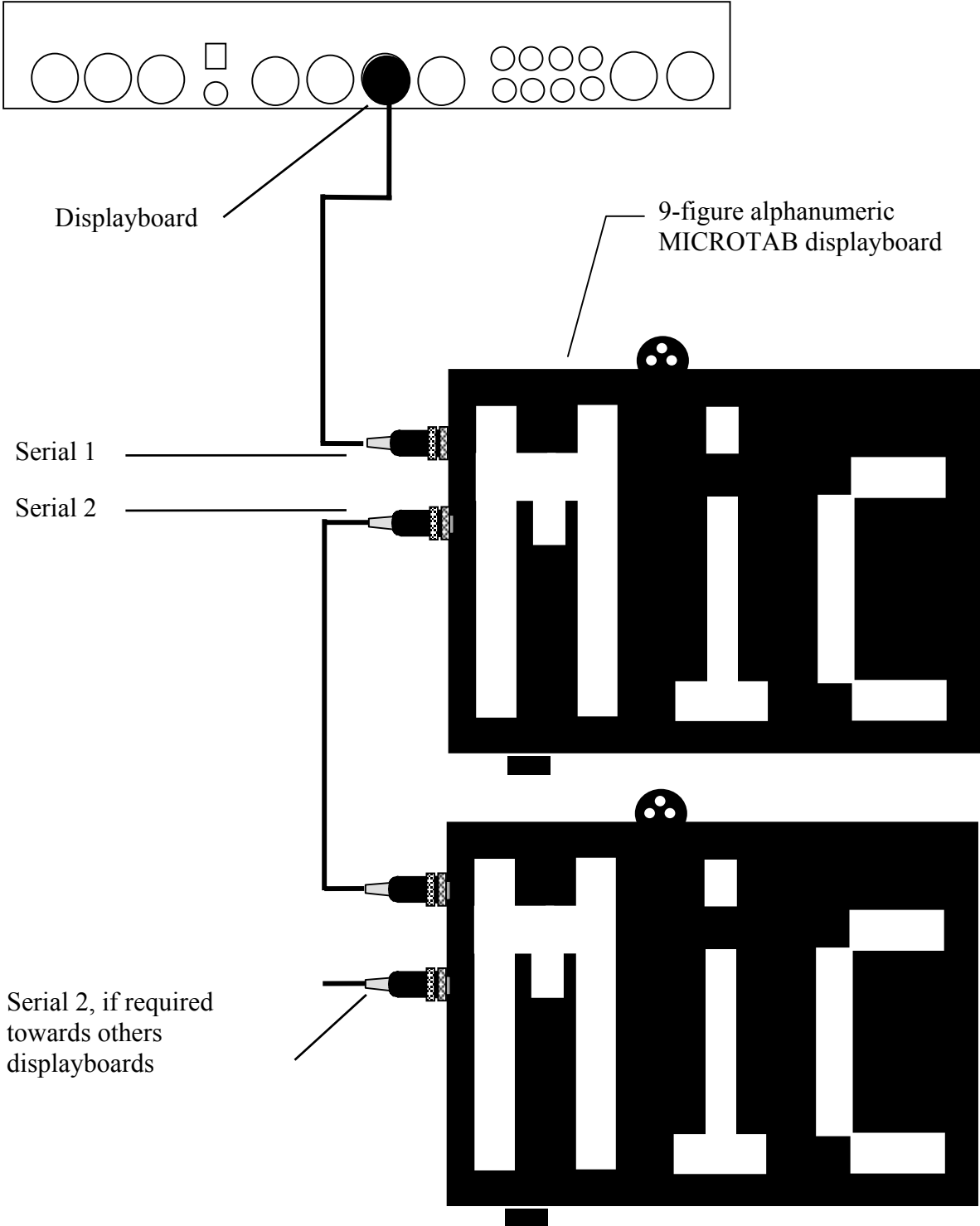

Fig. 14– Example of connection of two or more MicroTab displayboards



14. Menu structure

14.1. *Initial menu*

A: New race

A: Single starts

B: Group starts

C: Simple stopwatch

D: Parallel

Other

A: Show jumping

B: Swimming

C: PC-ONLINE

D: Dual timer

B: Delete/Recall stored race

C: Continue current race

D: Clear all memory

Others

A: Battery recharge

A: Discharge/recharge

B: Immediate recharge

C: Interrupt

B: LinkGate radio signal level test

C: Line status (main and pod)

D: Autotuning Battery

15. Maintenance

The only maintenance operations the user can perform are the recharging of batteries, external cleaning and the changing of paper.

In no circumstances should the device be opened. To do so will render the guarantee invalid. No maintenance must be carried out on an internal part outside a specialised laboratory.

15.1. Cleaning

If necessary REI2 can be cleaned with a damp cloth and a non-aggressive detergent. Do not use solvents such as trichloroethylene, acetone, benzine or other aggressive solvents. Do not let water get into the printer compartment. Remove any sand carefully by blowing it away.

15.2. Changing paper

The REI2 printer uses rolls of thermal paper which can be obtained from Microgate. Alternatively it is possible to use thermal paper, easily obtainable on the market (of the same kind normally used by POS and cash registers). In this case a few metres of the roll should be removed to reduce its diameter.

In most cases red bars are printed about 1 metre from the end of each roll to warn that it is ending. In this case there is 'autonomy' for about 150 time events.

To change the paper, follow these instructions:

- Open the printer compartment by turning the fastening screw in an anti-clockwise direction.
- Take out the finished roll, making sure you take out the central plastic spindle with it.
- Cut the strip about 5cm from the printer.
- Press the <Printer> key until all the paper has been taken out.
- Place the paper under the roller. It will be gripped and passed under the roller.¹
- Press the <Printer> key.
- Insert the spindle in the roll and place the roll in the compartment so that the spindle is inserted in the slots.
- Pass the paper through the slit in the cover of the printer and fasten with the screw.



Remember to press the <Printer> key to reactivate it after changing the paper. Until the key is pressed the printer remains inactive and no printout is made.

When no paper is inserted (or the head is in the 'unblocked' position) any lines to be printed are retained in REI2's memory and printed as soon as the paper is inserted (or the head is returned to the 'blocked' position).

¹ A special sensor detects the presence of the paper. If the paper is not gripped, either because it is cut badly or for any other reason, it can be gripped by pressing the <Printer> key and keeping this key pressed down until the paper has passed from the other side of the roll.

15.3. Releasing the paper

If necessary it is possible to withdraw the paper from the printer manually by releasing the head with the appropriate for this lever and carefully pulling it out with your hands. When you have finished this operation, reblock the head, again with the appropriate lever.



To avoid damaging the surface of the internal head, it should never be touched with metal or pointed objects.

16. Climatic conditions

REI2 has been tested in extremely difficult conditions of use. The optimal operational temperature range is between $-20\text{ }^{\circ}\text{C}$ and $+50\text{ }^{\circ}\text{C}$ with uncondensated humidity from 0 to 90%. At temperatures below $-20\text{ }^{\circ}\text{C}$ the speed at which the graphic display is updated may be reduced and there may be a loss of measurement accuracy of $0,05\text{ ppm}/^{\circ}\text{C}$. After a few minutes the inside of the device naturally warms up, limiting such problems.

Temperatures above $+50\text{ }^{\circ}\text{C}$ can cause a loss of measurement accuracy of $0,05\text{ ppm}/^{\circ}\text{C}$.

The maximum range of use is $-40\text{ }^{\circ}\text{C}$ to $+70\text{ }^{\circ}\text{C}$. The device should not be used outside this range.

The range for storage is from $-50\text{ }^{\circ}\text{C}$ to $+100\text{ }^{\circ}\text{C}$. If the device has been stored at a temperature outside its range of use, wait a few hours until it returns within the operational range.

17. Technical data

17.1. Connectors

All the connectors are seen from the contact side (and are also visible when you look at REI2 from the back). The connection schemes are provided for documentation. Microgate recommends the use of its own dedicated cables, which have undergone the EU standards tests.

6 pole DIN 45322 female panel connector

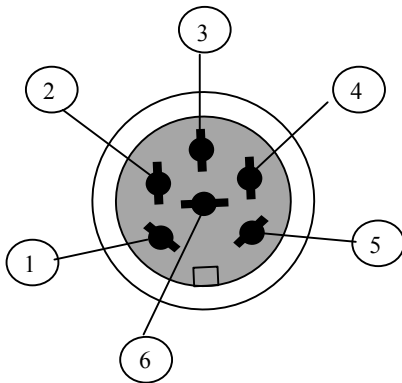

Fig. 15 – 6 pole DIN

180° 5 pole DIN 41524 female panel connector

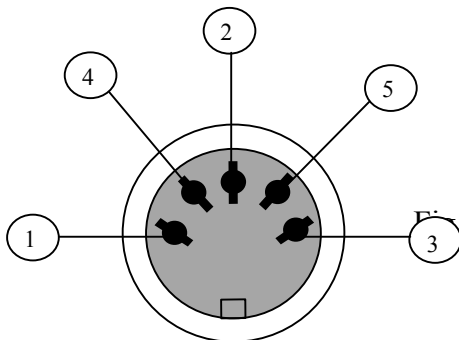

Fig. 16 – 180° 5 pole DIN

240° 5 pole Nucletron male connector

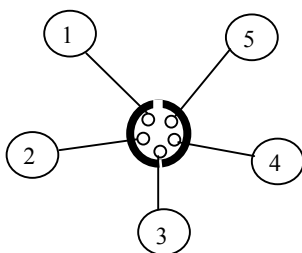

Fig. 17 – 240° 5 pole Nucletron

17.1.1. Supply

180° 5 pole socket for power supply

- 1 Ground
- 2 Not connected
- 3 External power supply input of from 9 to 24 allowed, maximum absorption 10 W¹
- 4 Not connected
- 5 Not connected

17.1.2. Analogue I/O

240° 6 pole socket for connection of analogue acquisition devices

- 1 Analogue input 0 (0..5V)
- 2 Analogue input 1 (0..5V)
- 3 Analogue input 2 (0..5V)
- 4 5V regulated output for power supply of external devices, max 800mA
- 5 Ground (reference for analogue inputs)
- 6 Not connected

17.1.3. Digital I/O

240° 6 pole socket for connection of digital acquisition devices

- 1 Digital input/output 0 (0/5V, configurable via software)
- 2 Digital input/output 1 (0/5V, configurable via software)
- 3 Digital input/output 2 (0/5V, configurable via software)
- 4 Digital input/output 3 (0/5V, configurable via software)
- 5 Ground
- 6 Digital output (0/5V)

17.1.4. Radio

5 pole miniDIN socket

- 1 Input
- 2 -10V, max 20mA
- 3 Output
- 4 Regulated 5V output, max 800mA
- 5 Ground

17.1.5. Computer A

240° 6 pole socket standard signal RS 232 no hardware protocol

- 1 Serial output (TXD)
- 2 Not used
- 3 RS232 input for flow control
- 4 RS232 output for flow control
- 5 GND
- 6 Serial input (RXD)

¹Between 9 and 11 volts REI2 is correctly powered but the internal batteries cannot be recharged.

17.1.6. Computer B

240° 6 pole socket standard signal RS 232

- 1 Serial output (TXD)
- 2 Not used
- 3 RS232 input for flow control
- 4 RS232 output for flow control
- 5 GND
- 6 Serial input (RXD)

17.1.7. Display Board

240° 6 pole socket standard signal RS 232 and RS 485

- 1 Serial output RS232 (TXD)
- 2
- 3 Serial output RS485 (+)
- 4 Serial output RS485 (-)
- 5 GND
- 6 Serial input RS232 (RXD)

17.1.8. Rei2 Net

240° 6 pole socket standard signal RS 485

- 1
- 2
- 3 Serial output RS485 (+)
- 4 Serial output RS485 (-)
- 5 GND
- 6

17.1.9. Timing Inputs

240° 6 pole socket signal at TTL level contacts not polarised

- 1 START
- 2 Regulated 5V output for power supply of external devices, max 800mA
- 3 Ground
- 4 LAP
- 5 STOP
- 6 AUX

17.1.10. LinkPod

240° 6 pole socket standard signal RS 485 (with galvanic insulation)

- 1 Optoinsulated serial output RS485 (+)
- 2 15V regulated output galvanically insulated from the device, max 150mA
- 3 Ground galvanically insulated from the device
- 4 Optoinsulated serial output RS485
- 5 Optoinsulated serial input/output RS485 (+)
- 6 Optoinsulated serial input/output RS485 (+)

17.1.11. Start

3.5 mono jack

17.2. *Sports homologization*

Data concerning sports homologization is available from Microgate.

17.3. *Technical conformity certificates*

Technical conformity certificates are available from Microsoft. Details of the certificates issued by Italy, Germany, France and Switzerland are given below.

Nation	Authority	Certificate
Italy	Ministero delle Telecomunicazioni	EMC/99/IST/027
Germany and Austria	TÜV	TPS A100 244L CEPT LPD-D
France	ART Autorité de Régulation des Télécommunications	99 0083 PPL 0
Switzerland	BAKOM OFCOM UFCOM	BAKOM 99.0044.K.P.

18. Guarantees and responsibilities

Microgate guarantees its products against defects of workmanship for a period of one year from the date of delivery.

Microgate cannot accept any responsibility for breakages of REI2 or other equipment due to incorrect connection of power sources or auxiliary devices, including those produced by Microgate, as a result of the use of unsuitable connecting cables.

Microgate cannot be held in any way responsible for any malfunctioning which may occur during the timing of any kind of event.

B

LINKGATE SYSTEM

1. Introduction to LinkGate

The transmission of an impulse via radio is a critical phase in timekeeping. The possibility of losing the data transmitted, of having very inaccurate timing and the transmission difficulties in some zones has often made timekeepers and trainers skeptical about this type of approach.

The LinkGate Encoder system represents a radical innovation in the field of radio transmission of impulses for timekeeping. Technological evolution makes it possible to go from the old impulse transmission systems to the more modern data transmission concept, which can guarantee extreme accuracy, redundancy of the information transmitted and greater reliability. In addition, the compact size of the system and the possibility of using modules which have built-in radio or modules which can be connected to any type of VHF or UHF transmitter radio make the LinkGate Encoder the ideal instrument for training and competitions at every level.

The components of the LinkGate system are:

	Type	Power supply	Radio
Encoder (Enc003)	Trasmitter	Lithium battery	Connectable to external transceiver
Decoder (Dec003)	Receiver	Taken from stopwatch	Connectable to external transceiver
Encoder (Enc005)	Trasmitter	NiMh internal batteries	Connectable to external transceiver
EncRadio (Enc004)	Trasmitter	NiMh internal batteries	With built-in radio module and connectable to external transceiver
DecRadio (Dec004)	Receiver	Taken from stopwatch	With built-in radio module and connectable to external transceiver

The use of modules with or without built-in radio is similar. Consequently in the following instructions, except when otherwise specified, the term Encoder will be used to refer to both the module of transmission with radio (Encradio) and to the module without radio (Encoder), and the term Decoder will refer to the receiving module (also with or without radio). The Encoder Enc003 and Encoder Enc005 modules are the same except for the type of power supply.

2. LinkGate Encoder: 3 features guaranteeing the reliability of radio transmission

To overcome unreliability and the various problems associated with the old concept of radio transmission of impulses, LinkGate Encoder offers a number of reliable and innovative solutions.

2.1. *Digital transmission of impulses*

LinkGate Encoder transmits a set of data (no longer a single impulse!) that contains a large quantity of information. In particular, the following are transmitted:

- The transmitter's code (which can be selected with the Channel Select switches)
- The Type of signal transmitted (Start, Lap number or Stop, which can be selected with the Signal Type switch)
- How long ago the event took place
- The Time taken to cover a speed base (if present).

To the set of data are added numerous control codes and error auto-correction codes which prevent a signal from being incorrectly interpreted during reception.

All the data (information + control codes) are transmitted 16 times, in order to reduce the possibility of reception failure.

Even with very disturbed signal transmission, this system ensures maximum reliability and precision (+/- 0.4 thousandths of a second); the complete reception of a single set of data is all that is required to reconstruct the original time of the event.

2.2. *The Repeat function*

If there are any problems in data reception, (radio malfunction, interference from a more powerful transmission, a cable which comes unplugged, etc...) you can use the REPEAT function. LinkGate Encoder allows you to repeatedly re-transmit impulses which have not been received, even after a considerable length of time has passed.

As soon as the transmission of an event begins, LinkGate Encoder starts counting the time from the start. By pressing the REPEAT key, you transfer the correct time to the stopwatch which takes into account the time which has passed up to that moment.

2.3. *Internal memorization of event times*

LinkGate Encoder is equipped with a Real Time Clock that allows you to use event times in event management. This special characteristic enables you to save the times of every event on a permanent memory, subsequently giving you the possibility through serial link of downloading its contents onto Microgate's stopwatches. The device stores the last 256 event times and speeds and so allows you to retrieve after an interval of time any data lost because of radio malfunction or any other reason.

3. Using the LinkGate Encoder

3.1. *Selecting the channel*

Every LinkGate Encoder is equipped with a 7 switch panel (CHANNEL SELECT switch from 2 to 8) for setting the transmission channel. The transmission channel is used in such a way that only the stopwatches REI2, Racetime2 and REI set to the same reception channel can receive the transmission signal as valid.

When turned on, the Microgate Racetime and REI stopwatches display the currently selected channel while REI2 indicates it and prints its configuration (both as a number and as an ON/OFF configuration of the LinkGate Encoder switches). By choosing the same switch configuration on the Encoders that you want to use, you can be certain to receive only the signals from your own timing system. This type of filter for signals being received is particularly useful as, by selecting different channels you can use several systems (stopwatch + Encoder) in the same zone and even on the same frequency without any risk of timings interfering with one another. For the REI2 stopwatch, consult the individual program manuals.

3.2. *Selecting signal type*

LinkGate Encoder makes it possible to identify the type of impulse that is being transmitted (START, LAP number or STOP). The rotary selector (marked SIGNAL TYPE) has 16 positions from 0 to F with the following meanings:

0= START
1= LAP n°1

A= LAP n°10
B= LAP n°11
C= LAP n°12
D= LAP n°13
E= LAP n°14
F= STOP

The type of signal is chosen by placing the number or letter for the signal you want next to the black dot by the words SIGNAL TYPE. (Note: the letters are written on the edge of the selector).

3.3. *Selecting working frequency*

To be able to communicate with each other the components of the LinkGate system must operate on the same radio frequency and with the same type of modulation.

Encoder e Decoder: For the LinkGate Encoder and LinkGate Decoder systems the setting of the working and modulation frequency is performed on the radio devices connected.

EncRadio e DecRadio: For LinkGate EncRadio and Linkgate DecRadio the working frequency can be varied by using the 4 switches (protected by a plastic window) on the back of both the transmitter and receiver. 16 different radio channels can be made available by exploiting the various combinations.

A sufficiently high level of the quality of the radio signal received by the LinkGate system is a necessary condition for its correct use. When you have completed configuration of the LinkGate system, we advise you to perform the '**LinkGate radio signal level test**', present in the various timing programs on the various stopwatches, to assess its quality.

By distributing the various frequencies available, complex LinkGate systems can be used at events which take place near each other without causing mutual interference.

3.4. Impulse transmission

An impulse can be transmitted in two ways:

1. with the manual activation key (SIGNAL key)
2. by means of any signal given by the closing of a contact normally open produced by a gate or photocell., using the BLACK banana jack as a ground and the GREEN banana jack as the signal.

At the end of data transmission, the LinkGate Encoder will emit a BEEP, which signals that the device has functioned correctly.

By using a switch (switch n. 1 next to the words SHORT IMPULSE LONG) you can set transmission duration (approximately 2.3 seconds for long transmission and 0.6 seconds for short). By selecting long transmission, you will obtain greater redundancy of information as the same data will be transmitted 16 times. If you select short transmission the set of data will only be transmitted 4 times so you will have lower redundancy but with a substantial reduction of transmission time.

For normal use, we advise you always to use long transmission (switch n. 1 OFF) in order to maximise the redundancy of transmitted data. However, for special applications such as the taking of several intermediate times very close together, using short transmission is the only practical solution if transmissions are not to overlap.

Encoder and Decoder: IMPORTANT: when using short impulse transmission, it is advisable to operate the receiving radio's "SQUELCH control so that it remains constantly activated. In this way, you will avoid losing impulses as a result of the delay caused when the transceiver switches over to reception.

3.5. The repeat function

If for some reason the last event was not received by the Microgate stopwatches you can retransmit it to them by pressing the REPEAT button even after a considerable interval of time.

If the problem should continue, the event can be re-transmitted as many times as necessary until satisfactory reception has been obtained.

3.6. Acquiring a speed

With LinkGate Encoder you can receive up to 16 pass-by speeds from as many different acquisition zones. The basic idea is to calculate the time taken to cover a speed base extremely accurately and transmit it together with the corresponding impulse (START, LAP or STOP). Then, by inserting the length of every single speed base into the Microgate stopwatch, you can obtain the value for the average speed for that stretch.

The input signal in the speed base must be brought onto the RED banana jack and the relative ground onto the BLACK banana jack (see cap. 5.1 Linkgate EncRadio on page 56); the output signal of the speed base must be brought onto the GREEN banana jack together with its ground which must be connected to the BLACK banana jack.

When an impulse is received from a speed base input (from the RED banana jack), LinkGate Encoder sets the time running. If within 8 seconds there is an impulse from the speed base output (from the GREEN banana jack), LinkGate Encoder will transmit the time between the two signals (time taken to cover the speed base) and the impulse of the speed base output (that is, the corresponding LAP or STOP impulse). In the case of a START signal (with the rotating selector on position 0), the impulse of the output signal from the speed base will always be transmitted, but the receiving stopwatch will reconstruct the correct time.

If more than 8 seconds pass between an input impulse in the speed base and an output impulse, the system will automatically discard the value – only transmitting the output impulse of the speed base (the signal corresponding to the GREEN banana jack).

3.7. Hardware resetting

It is possible to reset LinkGate Encoder to hardware mode. The hardware reset deletes all the data in the memory, sets the internal clock to zero and, if the system has crashed for any reason, restores it to an operational state. On the other side from the keyboard there is a hole in the case. By inserting a pointed instrument you will press a button which will reset it. We suggest you keep the button down for a few moments to ensure the machine has been reset.

3.8. Memory resetting

Resetting the memory causes the deletion of stored data and of the system's internal time. You can activate reset by keeping the 2ND key pressed down and then releasing the REPEAT (RESET) key. When this command has been received, LinkGate Encoder will emit three tones as follows: BOOP-BEEP-BOOP. The system is now reset!

3.9. Synchronization

LinkGate Encoder is equipped with a Real Time Clock which enables you to associate any event with a time. It is therefore possible to synchronize LinkGate Encoder's internal clock with any type of stopwatch. The procedure for synchronizing the system is as follows:

- Connect the ground (GND) of the stopwatch to LinkGate Encoder's BLACK banana jack
- Hold down the 2ND key and then press and release the SIGNAL (SYNC) key
- LinkGate Encoder will emit the tones BOOP-BEEP (the system is waiting for a START)
- Connect the start line to the GREEN banana jack
- Within two minutes give a start signal to synchronize the system (either by pressing the SIGNAL key or by closing the start line on the ground)
- On receiving the START signal, LinkGate Encoder will emit two tones tone: BEEP-BOOP (the system is synchronized)

If you wish to synchronize two or more Encoders with a stopwatch, the procedure remains the same. You must connect all the ground lines (BLACK banana jacks) with the ground of the stopwatch; then for every LinkGate Encoder you must activate the SYNC procedure (the second

point in the procedure), connect the start line with all the GREEN banana jacks and give a common START.

Note: LinkGate Encoder automatically synchronizes itself to the time 00:00:00.000; it is not possible to set other times.

3.10. Downloading data onto REI2

LinkGate Encoder memorises the last 256 events and the last 256 speeds (if acquired) on an internal permanent memory and so makes possible retrieval after an interval of time of any impulses lost as a result of radio malfunction or for any other reason. To be able to transfer the contents of LinkGate Encoder's memory onto the REI2 stopwatch, it is necessary to use the dedicated cable (CAB9), which should be connected to LinkGate Encoder's 5 pole connector at one end, and at the other to the 'Computer B' 5 pole connector (Fig. 15) on REI2. Once the correct menu has been selected on REI2's stopwatch (see manuals for the individual programs), you can proceed with data downloading by pressing the 2ND key and then by pressing and releasing the 'MODEM' (SERIAL) key. The start of downloading is signaled by the two tones BOOP-BEEP; then within 2 seconds two counters will appear on REI2's display to indicate the number of times and speeds actually downloaded. At the end of data downloading, the two tones BEEP-BOOP indicate that the procedure has terminated correctly.

Attention: if you download data immediately after performing a memory RESET (2ND + REPEAT (RESET)) and without transmitting any impulses, LinkGate Encoder will download the entire contents of the memory (256 times + 256 speeds).

IMPORTANT: During data downloading onto REI2, disconnect the LinkGate Decoder from the stopwatch. Also disconnect the data download cable during timing via radio.

3.11. Modem function

LinkGate Encoder can also be used as a modem transmitter. Contrary to what happens when transmission is generated during an event, however, the signal at the input does not take the form of sets of data with error correction codes, but is simply transformed into a signal compatible for radio transmission. Data reliability is left entirely to the efficiency of the radio system.

In this function mode, LinkGate Encoder accepts as input a Serial signal with a maximum speed of 1200 Baud and generates a FSK modulation between 1200 Hz (logic signal 0) and 1800 Hz (logic signal 1).

The digital input signal (level RS 232, RS 485 or TTL) is connected to the blue banana jack and the black banana jack.

The MODEM function can be activated by pressing the 'MODEM' key 3 times consecutively and rhythmically. At the first two presses, you will hear a BEEP tone. At the third, the tones BOOP-BEEP will signal entrance into MODEM function. If the key is not pressed with the correct rhythm, the system will refuse to enter this mode. The reason for this complicated procedure for activating this function is that the MODEM function quickly uses up the battery. In this way you can avoid the danger of rapidly running down the battery by accidentally touching the MODEM key.

To terminate the transmission session you need only press the MODEM key once. The system will emit the tones BEEP-BOOP to signal correct termination of the procedure.

3.12. Maintenance

3.12.1. Encoder Enc003

This module is designed to avoid the need for any type of standard maintenance. In normal working conditions the lithium battery (3.6 V) has a life of approximately 6 years. When the LinkGate Encoder is in a situation of limited autonomy, it emits an acoustic signal to warn the user. The low battery signal consists of three brief tones BEEP-BEEP-BEEP at the end of an impulse transmission. In this case, you should immediately contact your Microgate representative or the company for battery replacement and an overhaul of the system.

3.12.2. EncRadio Enc004 and Encoder Enc005

The Encradio (Enc004) and Encoder (Enc005) modules are powered by internal NiMh batteries, which can be recharged with the adaptors supplied. They can be used without recharging for about 10,000 impulses or 8 hours in the displayboard command mode. When LinkGate radio's power is running low, it warns the user with an acoustic signal. The low battery signal consists of the emission of 3 brief BEEPs at the end of the transmission of an impulse. Usually, the power remaining is sufficient to finish the timing session.

Any power source between 9 and 20 Volts can be used to charge the internal batteries and also for external power supply. To increase the life of the internal batteries, it is advisable to recharge only after the low battery warning or after 3 months of not being used.

3.12.3. Decoder e DecRadio

The Decoder and DecRadio modules take power directly from the Microgate stopwatch using the dedicated connecting cable.

4. Licences

Encoder and Decoder: For the use of the LinkGate Encoder and Decoder modules, check the regulations for radio transmissions of the country in which you intend to use them. (In Italy, with the exception of specific cases, users of transceivers must have a licence).

DecRadio and EncRadio: The DecRadio and EncRadio modules do not require a licence (in Italy and the EU) when functioning with the built-in radio module. Details of homologization and licensing are given below.

Italy: DGPGF/4/2/03/339883/F0/0004199

Germany/Austria: TPS A 100 244 L

France: 990083PPL0

Switzerland: 99.0044.K.P

UK: 14033

5. Figures

5.1. Linkgate EncRadio

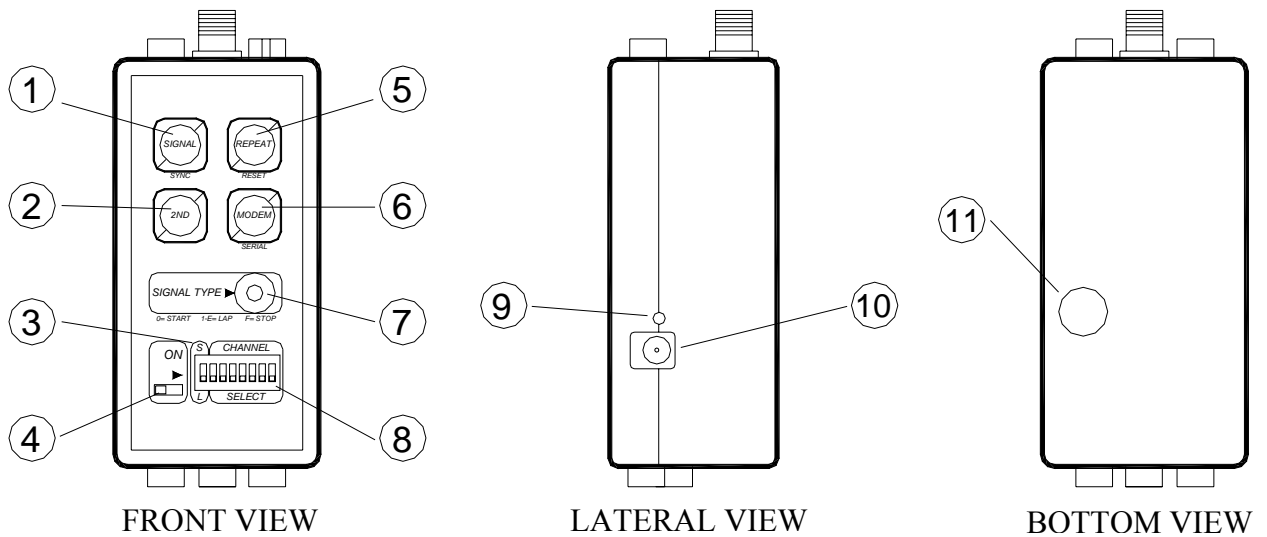

- 1 SIGNAL button
- 2 SECOND FUNCTION button
- 3 Selector for redundancy of signal transmitted (Long/Short)
- 4 On/Off switch
- 5 REPEAT button
- 6 MODEM button
- 7 Rotating selector for type of signal transmitted (Start, Lap, Stop)
- 8 Channel transmission selector
- 9 LOW BATTERY led
- 10 Jack connector for battery recharge
- 11 Cover for access to DIP SWITCH selector for transmission frequency

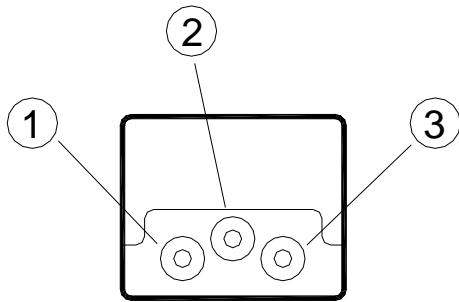

V BOTTOM VIEW

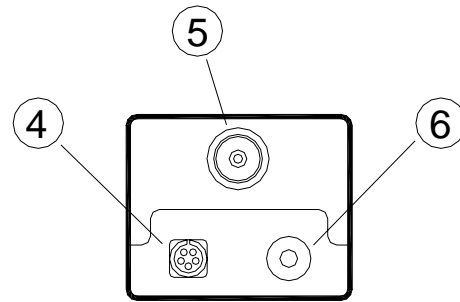

VI UPPER VIEW

- 1 SIGNAL signal banana jack (GREEN)
- 2 Earth signal banana jack (BLACK)
- 3 SPEED signal banana jack (RED)
- 4 5 pole Nucletron connector for Radio connection and data download
- 5 BNC for external antenna connection
- 6 MODEM input banana jack

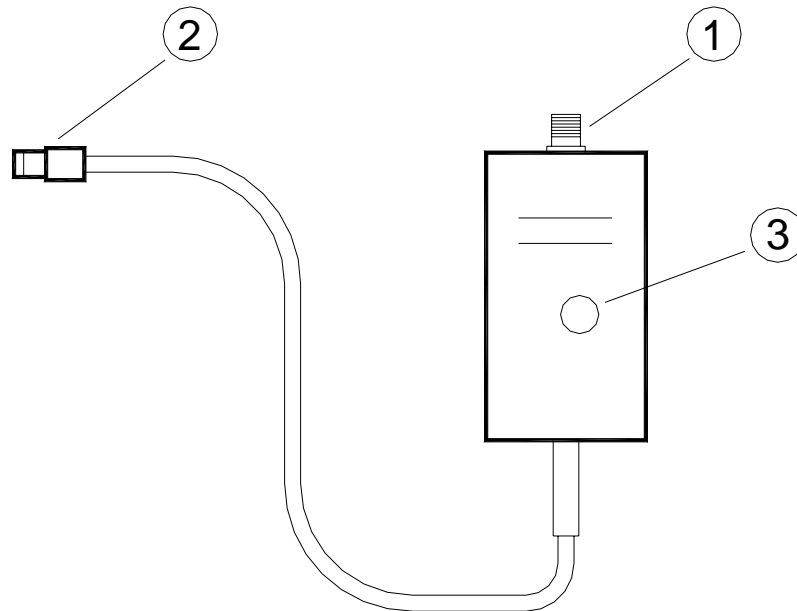
5.2. Linkgate DecRadio**5.3. DecRadio**

- 1 BNC for external antenna connection
- 2 5 pole Nucletron connector for Radio output
- 3 Cover for access to DIP SWITCH

5.4. Taking the speed

Fig. 18 – Taking the speed

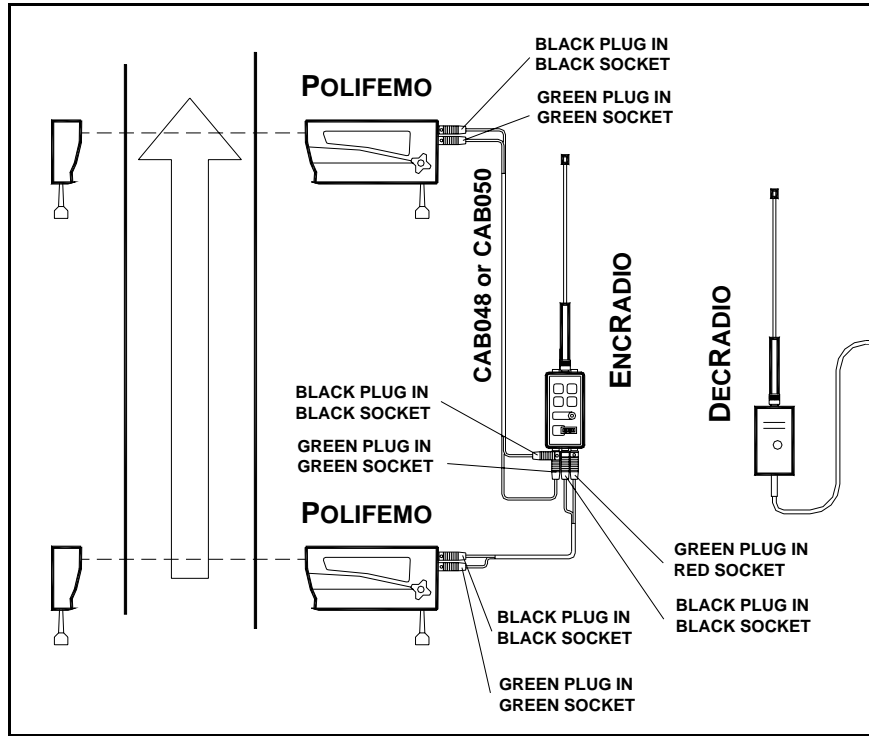

C

LINKPOD SYSTEM

1. Introduction to LinkPod

The LinkPod system allows you to connect a maximum 80 external lines to REI2, in addition to the 4 available on the device. For each line the logical channel to which it corresponds, disactivation times and possible activation and disactivation can be individually specified.

The system consists of a variable number of Pods (maximum 10) and their respective connecting cables.

1.1. *Information transmitted*

The Pods do not send REI2 a simple signal of opening or closing of contact but transmit sets of information containing the moment at which the event took place and the line and Pod which acquired it. The protocol used for transmission is RS 485. Each Pod deals with any conflicts of transmission.

1.2. *Measurement and speed precision*

The accuracy of measurement obtained by using the LinkPod system is the same as that obtained by using the normal input lines of REI2.

The Pods keep themselves synchronized with REI2 by using a special synchronization signal sent by REI2. Consequently the maximum time lag is always lower than REI2's resolution (1/25,000s).

The system can acquire and transmit to REI2 the status and events acquired by any module in a very short time (maximum 150 ms). Therefore also simultaneous events, such as the simultaneous closing of all 80 contacts, are acquired and reported to REI2 within 150 ms, maintaining maximum accuracy of measurement.

1.3. **The Pod**

Every pod has a series of 8 input lines, 2 connectors for connection to the other Pods and the stopwatch, a device for setting the number of Pods (address) and a series of switches for the N/O or N/C configuration of the inputs.

The number assigned to the Pod must be different for each of the Pods connected. When you assign numbers, you do not necessarily have to follow the order in which the Pods are connected to each other but can number as you like. However, it is advisable to assign numbers consecutively to simplify the identification of the lines.

The lines of each Pod can be individually configured as N/O or N/C independently from each other and from every other Pod.

The cable is used to supply power and the synchronization signal and to transmit the sets of data containing the information concerning the events acquired (time, number of pods and line). It is therefore advisable to use the dedicated Microgate cables, type CAB092, or cables of similar quality.

The maximum distance between REI2 and the farthest Pod is about 1000 m.

Connection cables of different sizes are available. The cable used consists of 3 twisted pairs with watertight Amphenol connectors at the ends.

1.4. *Insulation*

The external lines are galvanically insulated from the stopwatch power supply according to CE specifications and so can also be used at a swimming pool.

1.5. *Maintenance*

After being used at a swimming pool, the Pods should be washed in running water and left to dry before they are put away to avoid damage from chlorine. (The chlorine mist present in swimming pools is very aggressive and can attack any material). The connection cables, in particular the connectors, should be washed and dried.

1. Editing history

The table below summarises the main changes made to this document.

Program version	Chapter	Page	Editing description
1.03			Removal of introductory chapter to transmission protocol, now inserted in the manual 'Transmission protocol'.
1.06	6.3	18	New function Synchronization verify
1.06	6.4	18	New function Signal
1.06	10	25	New function Switching off
1.06	11	26	Function changed Memorization
1.07.9			Editing for version 1.07.9

	REI2 User manual	Doc: R2U_2_1079_002_E Version: 1.07.9 Page 64 of 64
---	---------------------	---

Copyright

Copyright © 1999, 2005 by Microgate s.r.l.
All rights reserved

No part of this document or of any of the individual manuals may be copied or reproduced without previously making a written application to Microgate s.r.l. for authorisation.

All the marks or names of products mentioned in this document or in the individual manuals are or may be registered marks belonging to the individual firms.

Microgate, REI2, REI, RaceTime, MicroTab, μ Tab, MicroGraph, μ Graph, MicroBeep, μ Beep, Uploader, Microrun, MicroLink, μ Flasher, LinkPod, LinkGate, LinkGate encoder, LinkGate decoder, EncRadio, DecRadio, Polifemo, MicroSem, μ Sem, are registered marks of Microgate s.r.l. or of licensed users.

Microgate s.r.l. reserves the right to modify the products described in this document and/or in the relative manuals without notice.

Collaborators in the creation of REI2 and the preparation of the relative manuals are:

Ing. Roberto Biasi
Dr. Vinicio Biasi
Ing. Federico Gori
Ing. Alessandro Miorelli
Giuliano Menestrina
Daniele Veronese

The software and manuals are available in the following languages: Italian, English, German and French.

Microgate S.r.L
39100 Bolzano - Bozen
Via Stradivari, 4 Stradivaristr.
ITALY

Tel. +39 471 501532 - Fax +39 471 501524
e-mail info@microgate.it

